



TL1250P R5 4K Resolution Day/Night lens for 1/1.7" sensors

- ✓ Ultra high resolution for 4K cameras, up to 12.4 megapixel
- ✓ P-iris for precise aperture control
- ✓ Fully motorized with zoom, focus, iris, and limit switches
- ✓ Optional motor control board (MCR500) available for easy integration
- ✓ IR corrected for true Day/Night cameras
- ✓ Compact design to fit into domes as small as 4" mini-dome size
- ✓ CS-mount
- ✓ Used for sensor sizes 1/2.5", 1/2.3", 1/2" 1/1.8", and up to 1/1.7" (Sony IMX178, Sony IMX226 for example)

Focal length (FL)	12-50mm
Mount type	CS-mount
Iris type	P-iris
Image circle	Ø9.4mm at FL 12mm
Resolution	12.4 megapixel
F/#	F/1.8 @ 12mm - F/2.4 @ 50mm to close
IR Correction	440nm – 950nm (Day/Night)
Focus Range	2.0m - infinity
Lens length (TTL)	< 64mm TTL
Back focal length (BFL)	8.2mm (in air)
Chief ray angle (CRA)	< 7°
Geometric distortion	< 10% at 12mm, < 2% at 50mm
Relative illumination	>40%
Lens transmission	>80%
Weight	75g
Operating temperature	-20C to 60C (<70% humidity, non-condensing)
Storage temperature	-30C to 70C (<90% humidity, non-condensing)

Field of view for sensor sizes (12mm – 50mm)

Sensor size	1/1.7"	1/1.8"	1/1.8" 4K*	1/2"	1/2.3"	1/2.5"
Horizontal	36° - 8.6°	36° - 8.6°	35° - 8.5°	30° - 7.4°	30° - 7.2°	27° - 6.7°
Vertical	26° - 6.5°	23° - 5.8°	17° - 4.3°	23° - 5.6°	22° - 5.5°	20° - 5.0°
Diagonal	46° - 11°	44° - 10°	40° - 9.5°	39° - 9.2°	38° - 9°	34° - 8.3°

*4K format = 4000 x 2000 pixels



Visit Theia's website for more information about the lenses.

Lens drawing

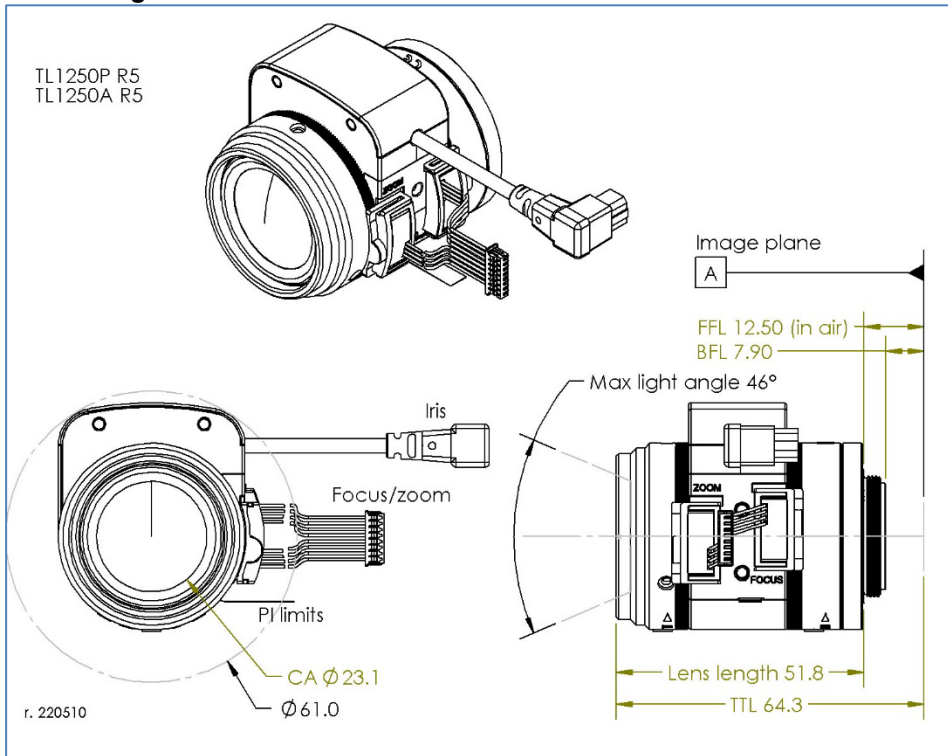

CAD models can be
downloaded from
TheiaTech.com/1250CAD

Entrance pupil location

The entrance pupil location is located inside the lens and for the longer focal length, even behind the image sensor position. It is measured from the vertex of the lens at the input side. The lens vertex is 0.5mm below the plastic front ring of the lens.

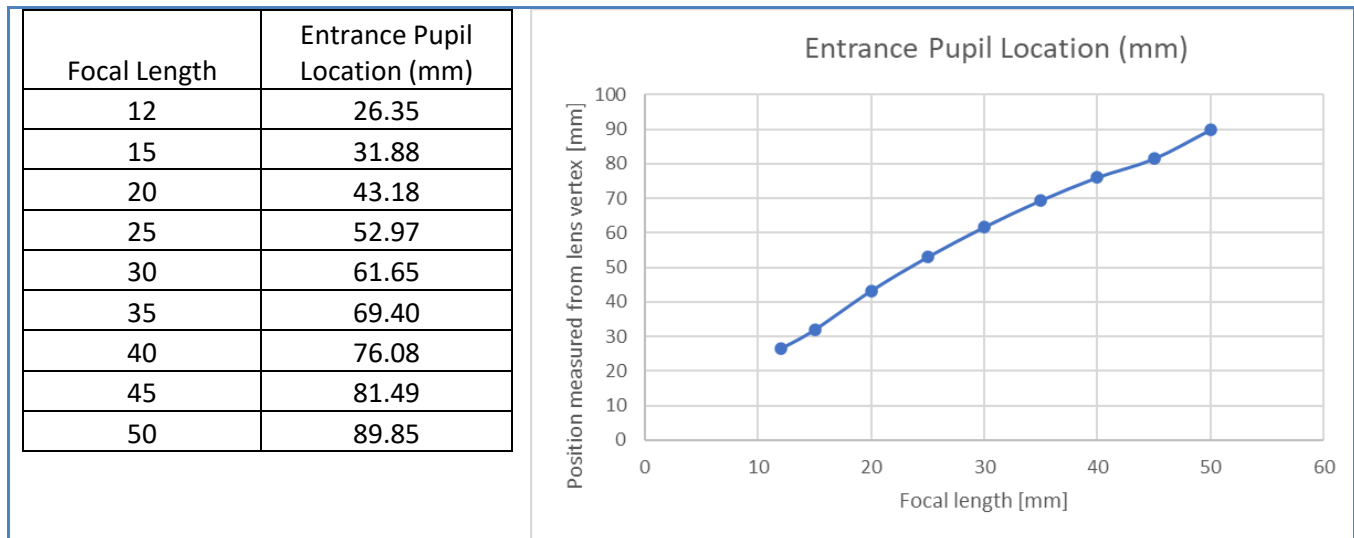

Zoom/Focus motor specifications

Drive	Stepper motor 2 phase bipolar drive
Operation voltage	3.3V (range 2.6-4.8V)
Maximum motor temperature*	Do not let motor temperature exceed 92°C
Coil resistance	28.5Ω (±7%)
Zoom number of steps	3256 steps between hard stops
Zoom speed range**	600-1000pps
Zoom cam rotation	75°
Focus number of steps	8467 steps between hard stops
Focus speed range**	600-1000pps
Focus cam rotation	195°
Focus/zoom connectors	Housing: Molex 51021-0800 Terminal: Molex 50058-8000
Cable length	150mm

Zoom: Wide -> Tele				
Focus: Near -> ∞				
Step	A+	A-	B+	B-
0	H	L	H	L
1	L	H	H	L
2	L	H	L	H
3	H	L	L	H

Pin	Color	Function	Motor
1	Brown	A+	Focus
2	Red	A-	Focus
3	Orange	B+	Focus
4	Yellow	B-	Focus
5	Brown	A+	Zoom
6	Red	A-	Zoom
7	Orange	B+	Zoom
8	Yellow	B-	Zoom

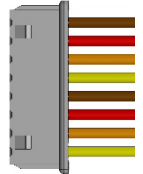

*Theia's motor temperature calculator can be used to estimate the focus and zoom motor temperatures after a set number of run/ cool down cycles. This can be downloaded from Theia's website (see the QR code below).

The example below shows 60C ambient temperature and 3.5V motor. The motor is driven for 10 seconds with 10 seconds cool down between moves. After 3 moves, the motor is allowed to cool down which takes about 4 minutes.

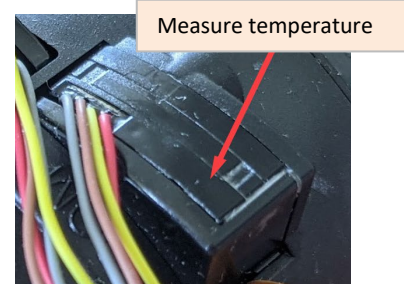
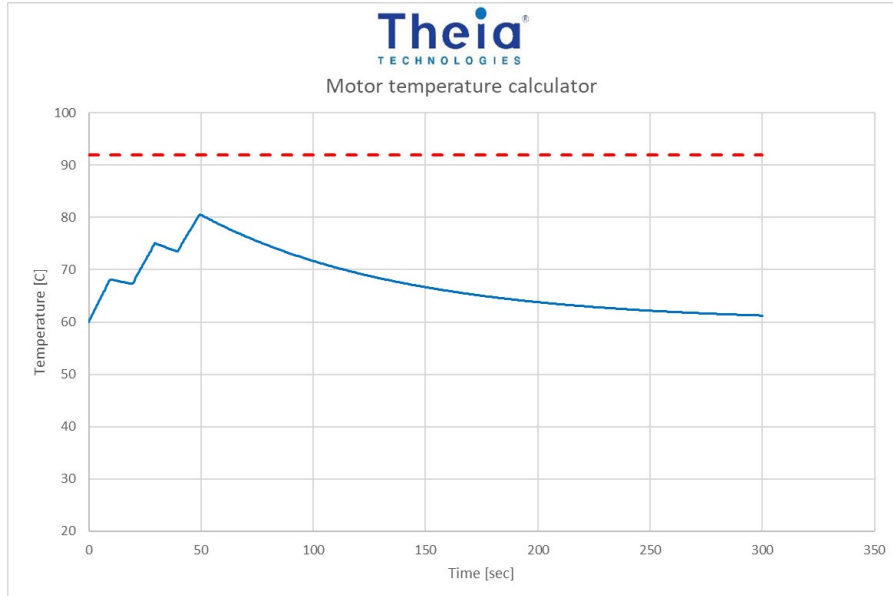

Motor temperature calculator
TheiaTech.com/calculators

Zoom and focus **motor positions may be affected by backlash and lost steps during movement. Lost steps are affected by the driving conditions. It is best to drive the motor between 600pps and 1000pps with 4-12 steps of acceleration/deceleration. Acceleration is especially helpful at higher driving speeds. Within these limits, the lost steps are tested to be <40 steps per full zoom range and <45 steps per full focus range.

Backlash is variable from lens to lens and move to move. For zoom, expected backlash is approximately 15-20 steps and for focus it is approximately 30-40 steps.

Zoom/Focus motor step map (at infinite focus position).

Zoom motor		Focus motor	
<i>Note</i>	<i>Step</i>	<i>Note</i>	<i>Step</i>
Hard stop (wide)	3256	Hard stop (far)	8466
Wide design position	3256	Far focus design	8140
PI position	3147	PI position	8031
Tele design position	0	Near focus design	326
Hard stop (tele)	0	Hard stop (near)	0

Zoom/Focus synchronizing map (observe min/max motor speeds)

Focal length	Zoom motor note	Zoom motor step number	Focus motor note	Focus motor step number
<i>[mm]</i>		<i>[#]</i>		<i>[#]</i>
12.36	Wide end	3256		5104
14.83		2735		6007
18.05		2214		6776
22.28		1693		7241
27.86		1172		7080
35.20		651		5687
49.00	Tele end	0		0

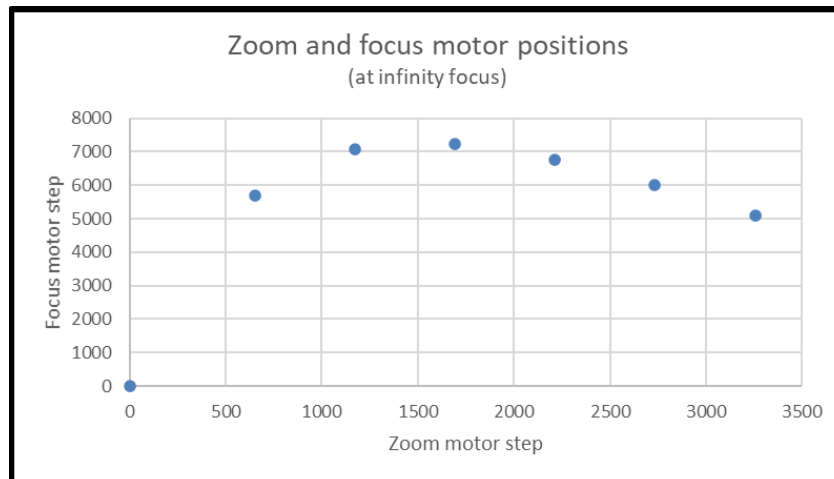

Notes:

These motorized lenses are intended for integration into cameras and require motor drivers and controllers. Typically, Theia works with the camera manufacturer to ensure that the camera motor controller matches the lens. It is possible to supply your own motor controller, but Theia cannot guarantee that your motor controller will not damage the lens. Theia does not offer any warranty on the suitability of these motorized lenses for any particular camera. These motorized lenses are **not intended for continuous use** of the motors as in PTZ applications. Theia offers motor control boards that are suitable to control motorized lenses with P-iris.

P-iris motor specifications

Drive	Stepper motor 2 phase bipolar drive
Operating voltage	4V (+/-1)
Number of steps	75 (open to closed)
Basic step angle	18°
Maximum response freq.	200pps
Coil resistance	30Ω

P-iris: open->close				
Step	A+	A-	B+	B-
0	H	L	H	L
1	L	H	H	L
2	L	H	L	H
3	H	L	L	H

Connector type 2 (CCTV)

Connector type	Housing: EYC 221
Cable length	300mm

Pin	Function
1	B+
2	A+
3	A-
4	B-

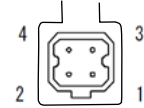

P-iris motor map

Step	Aperture Size [mm ²]	F/# (at FL=12mm)
1	95.0	1.84
5	90.8	1.88
10	82.1	1.98
15	72.8	2.10
20	63.4	2.25
25	54.0	2.43
30	44.9	2.67
35	36.0	2.98

Step	Aperture Size [mm ²]	F/# (at FL=12mm)
40	27.7	3.39
45	20.0	3.98
50	13.2	4.90
55	7.5	6.52
60	3.1	10.10
65	0.8	19.34
70	0.1	69.29
72	0.0	Closed
75	0.0	Closed

Zoom/Focus limit switch

Type	Photo interrupter phototransistor
Part model	Sharp GP1S396HCPSF
Operating voltage	3.3V
Output level	>2.2V HIGH <0.6V LOW
Connector type	FPC cable
Board-side mating connector type (not supplied)	Molex 52746-0671 Molex 52745-0697 Molex 52559-0652
Cable length	150mm

Pin*	Function	Motor
1	Emitter	Focus
2	Anode/Collector	Focus
3	Cathode	Focus
4	Emitter	Zoom
5	Anode/Collector	Zoom
6	Cathode	Zoom



*cable side pin designation matches Molex 52746-0671 bottom side contacts connector
Recommended circuit for each photo interrupter

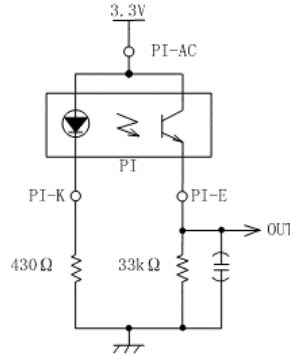

Alternate lens options

There are other lens configurations. The options listed in the table below may or may not be available. Please visit www.theiatech.com to learn more about our other lens options.

TL1250x-###x R6 -xx

Lens	Iris type	IR wavelength	Alternate filter type	Motors	Mount type
TL1250	A: DC autoiris P: P-iris	(blank): visible + clear glass IRC 850: notch filter 940: long wave pass filter	V: IR blocking, visible transmitting C: clear glass, visible and IR transmitting	R6	(blank): CS mount CS: CS mount D25: Ø25mm board mount

Theia® PN	Varifocal	Mount type	Mount slip ring	Iris type	CCTV iris con.	Molex iris con.	IR corrected (day/night)	Filter switch (vis/clear)	Filter switch (vis/940nm)	Filter switch (clear/940nm)	Zoom motor	Focus motor	PI limits	Focal length	MP rating	f/#	Image circle	Biggest sensor format	MOD [m]	Lens Length (to mount)	Lens Length (TTL)	Weight [g]
TL1250A R6	✓	CS	✓	A	✓	✓	✓				✓	✓	PI	12-50	12 (4K)	F/1.8	9.4	1/1.7"	2	52	64.5	72
TL1250A R5	✓	CS	✓	A	✓	✓				✓	✓	PI	75									
TL1250A R4	✓	CS	✓	A	✓	✓	✓			✓	✓		71									
TL1250P R6	✓	CS	✓	P	✓	✓	✓			✓	✓	PI	68									
TL1250P R6 25	✓	D25		P	✓	✓	✓			✓	✓	PI	70									
TL1250P R5	✓	CS	✓	P	✓	✓				✓	✓	PI	71									
TL1250P R4	✓	CS	✓	P	✓	✓	✓			✓	✓		67									
TL1250A-940V R6	✓	CS	✓	A	✓	✓		✓		✓	✓	PI	72									
TL1250P-940V R6	✓	CS	✓	P	✓	✓		✓		✓	✓	PI	72									
TL1250P-940C R6	✓	CS	✓	P	✓	✓			✓	✓	✓	PI	72									
Related versions without motorized zoom and focus																						
SL1250M	✓	CS	✓	M		✓								12-50	12 (4K)	F/1.8	9.4	1/1.7"	2	52	64.5	65
SL1250P	✓	CS	✓	P	✓	✓							69									
SL1250A	✓	CS	✓	A	✓	✓							70									

For more information contact

Theia Technologies
 info@TheiaTech.com
www.TheiaTech.com
 +1-503-570-3296

Revisions:

Version	Change	Reason
220510	Templated spec sheet	Family spec sheet can be reduced for each lens model to simplify spec sheet